

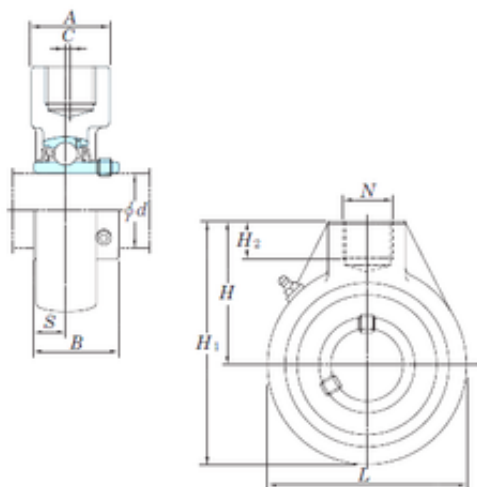

Bearing Rolamentos do Brasil Ltda.



KOYO UCHA210-32 bearing units

Bearing No. UCHA210-32

Bore Diameter	50,8 mm
Width	51,6 mm
d	50,8 mm
A	48 mm
B	51,6 mm
C	5 mm
H	83 mm
H1	142 mm
H2	21 mm
L	118 mm
S	19 mm
Bolt (G)	PF 1
Weight	2,1 Kg
Basic dynamic load rating (C)	35,1 kN
Basic static load rating (C0)	23,3 kN

UCHA210-32 Bearing 2D drawings and 3D CAD models